

MB999

Load Pin

Content of Loadpin Datasheet

Page 1 ... General

Page 2 ... Mounting Situation

Page 3 ... Output Signal & Wiring

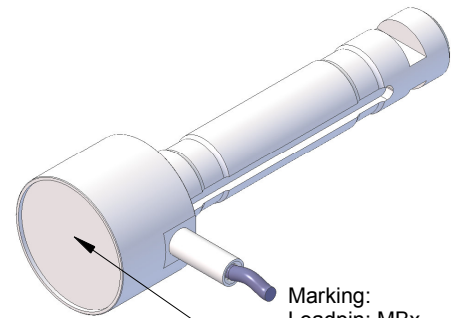
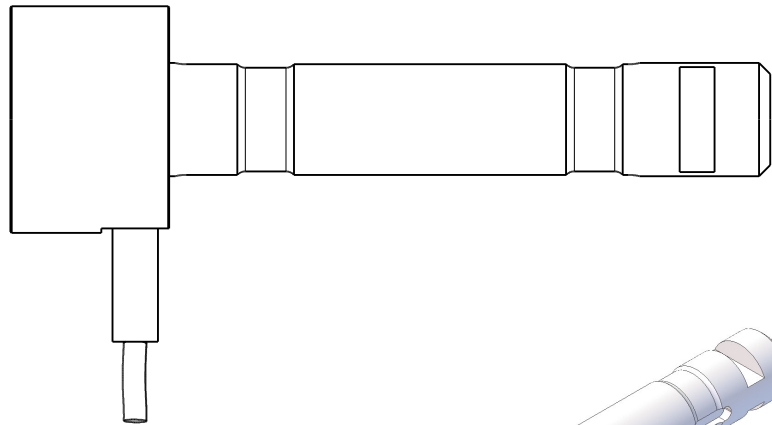
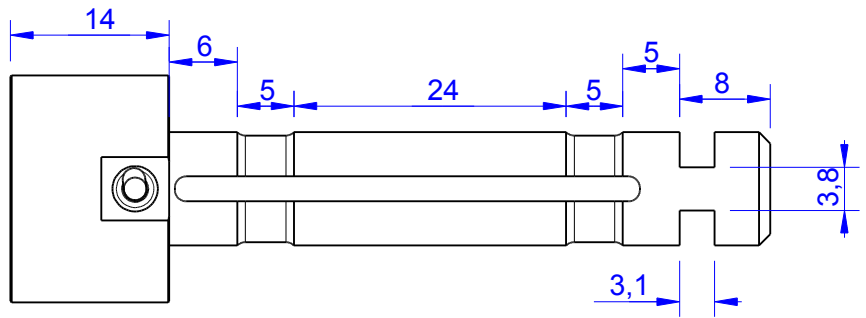
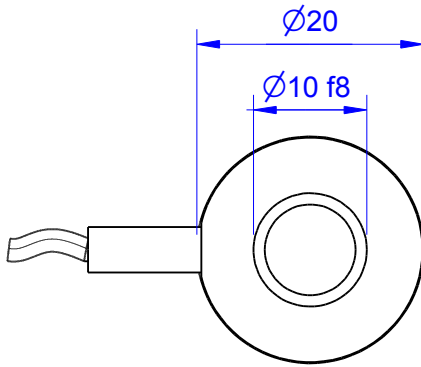

Marking:
Loadpin: MBx
Orderno.: MBx-xxx-x-x
Serialno.: xxxxxxxx
www.batarow.com
Made in Germany

Order-number	Capacity (F.S.)	Uncertainty (k=2)	Review
MB999-2-x-A	2 kN	±0,06kN	A
MB999-4-x-A	4 kN	±0,12 kN	A
MB999-8-x-A	8 kN	±0,24 kN	A
MB999-10-x-A*	10 kN	±0,30 kN	A

* above showed version
The fixed dimensions don't change at the other capacity.

Specifications:

Dimension / Material		
Material		Steel
Protection class		IP 64
Hardness (load area)	HRC	58
Mechanical Data		
Safe Load Limit	% of F.S.	120
Breaking Load	% of F.S.	200
Precision		
Nonlinearity	% of F.S.	±0,5
Nonrepeatability	% of F.S.	±0,25
Hysteresis	% of F.S.	±0,2
Temp. Shift Zero	% of F.S./K.	±0,05
Temp. Shift Span	% of F.S./K.	±0,05
Temperature		
Compensated Temp.	°C	-10...+60
Operating Temp.	°C	-20...+70

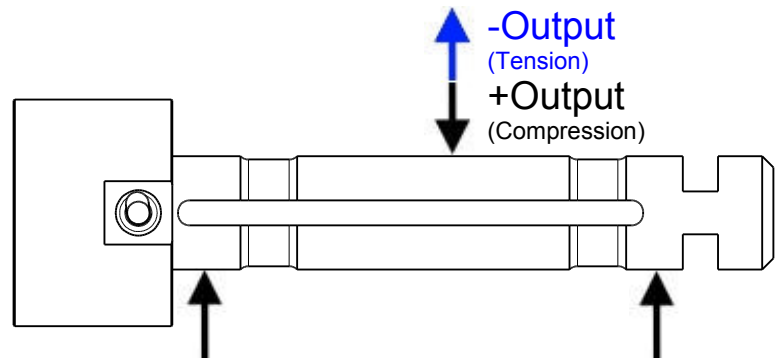

Batarow
Made in Germany

Batarow Sensorik GmbH
Pappelweg 16
18276 Lüssow OT Karow

Mail: info@batarow.com
Phone: +49 (0) 3843-855555
Fax : +49 (0) 3843-218842

Internet:
www.batarow.com

Mounting Situation

MB999 Review: A

Bore fit of mounting situation: H7

Configuration

possible mounting situation / customer mounting could vary

(Please describe mounting situation with Vs, Ws, Xs, Ys and Zs for best possible calibration)

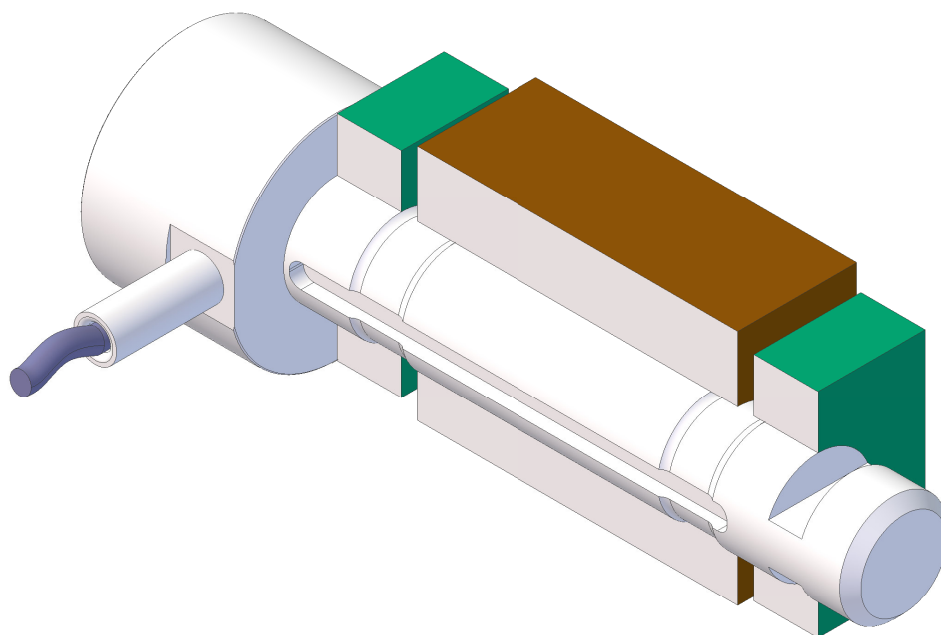
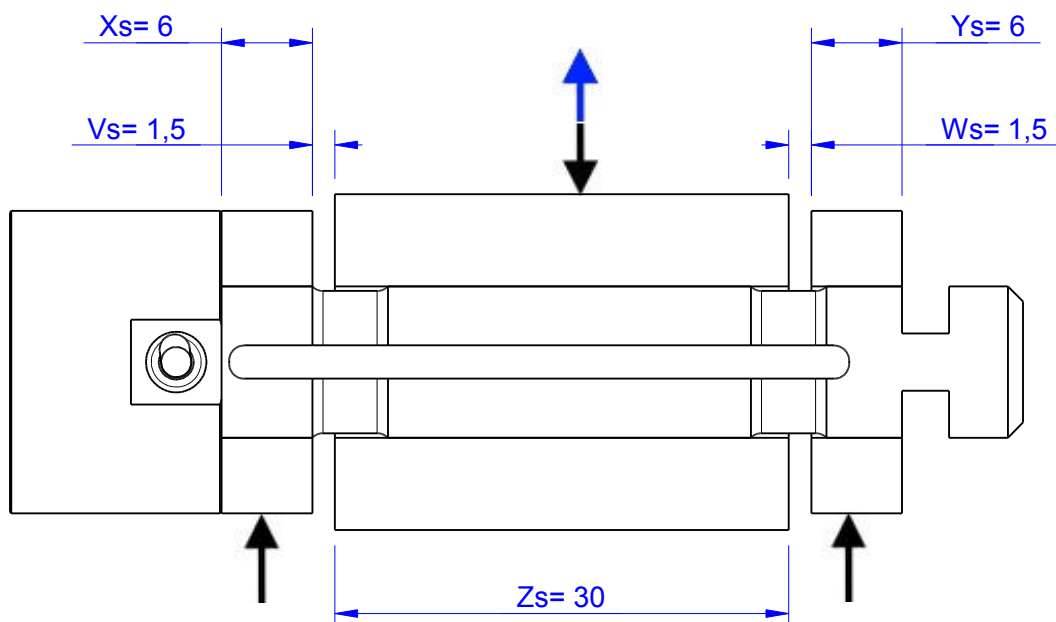

Batarow
Made in Germany

Batarow Sensorik GmbH
Pappelweg 16
18276 Lüssow OT Karow

Mail: info@batarow.com
Phone: +49 (0) 3843-855555
Fax : +49 (0) 3843-218842

Internet:
www.batarow.com

Output Signal & Wiring

MB999 Review: A

Analog Output mV/V (S1)

Electrical Data		
Rated Output	mV/V@F.S.	2
Zero Balance	mV/V	±0,05
Excitation (Maximum)	Volt	10
Input Resistance	Ohm	1200±200
Output Resistance	Ohm	1002±2
Insulating Resistance	GOhm	>5

Wiringcode: WC50		Cabletype: stc31v		
Cable Length	Excitation (+)	Excitation (-)	Bridge (+)	Bridge (-)
3 m	red	black	green	white

Ordernumber Add-On:
MBxxx-x-S1-x

Analog Output Voltage

Electrical Data U5		
Output @ -F.S.	V	0,5±0,2
Output @ 0kN	V	2,5±0,2
Output @ +F.S.	V	4,5±0,2
Supply Voltage	V	12±1
Current Consumption	mA	50 (@ 12V)
Bandwidth	kHz	2,2±0,2

Wiringcode: W508			
Cabeling: 3 m STC-31v			
Supply(+)	Ground (-)	Output	n.c.
red	black	green	white

Ordernumber Add-On:
MBxxx-x-U5-x

Analog Output Current

Electrical Data I4		
Output @ -F.S.	mA	4±0,3
Output @ 0kN	mA	12±0,3
Output @ +F.S.	mA	20±0,3
Supply Voltage	V	12±1
Current Consumption	mA	45 (@ 12V)
Bandwidth	kHz	2,2±0,2

Wiringcode: W508			
Cabeling: 3 m STC-31v			
Supply(+)	Ground (-)	Output	n.c.
red	black	green	white

Ordernumber Add-On:
MBxxx-x-I4-x

Attention: Nipple orientation of connector is not fixed. In case of 90° connector - it is necessary to set by customer.

*Attention: With this output configuration is no negative signal (Tension) possible. Please ask our engineering for 4..12..20mA; 1..5..9V or ±10V versions.

Batarow
Made in Germany

Batarow Sensorik GmbH
Pappelweg 16
18276 Lüssow OT Karow

Mail: info@batarow.com
Phone: +49 (0) 3843-855555
Fax : +49 (0) 3843-218842

Internet:
www.batarow.com