

MB862

Load Pin

Content of Loadpin Datasheet

Page 1 ... General

Page 2 ... Mounting Situation

Page 3 ... Output Signal & Wiring

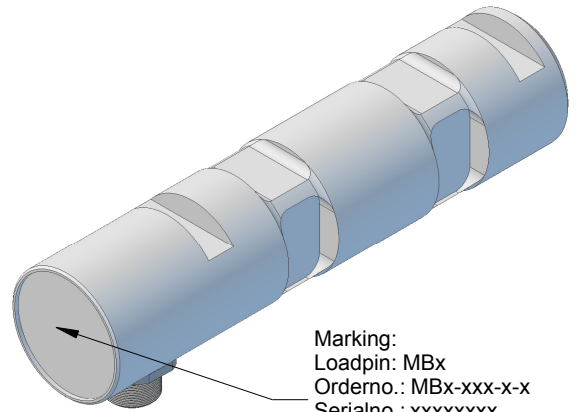
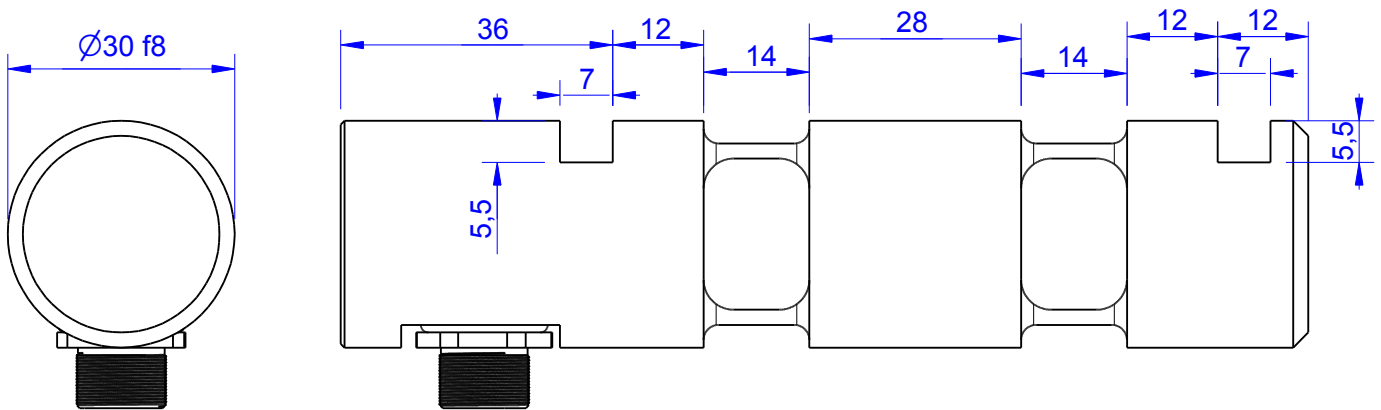

Marking:
 Loadpin: MBx
 Orderno.: MBx-xxx-x-x
 Serialno.: xxxxxxxx
 www.batarow.com
 Made in Germany

Order-number	Capacity (F.S.)	Uncertainty (k=2)	Review
MB862-5-x-A	5 kN	±0,025kN	A
MB862-10-x-A	10 kN	±0,05 kN	A
MB862-15-x-A*	15 kN	±0,08 kN	A
MB862-50-x-A	50 kN	±0,25 kN	A
MB862-75-x-A	75 kN	±0,35 kN	A

* above showed version
 The fixed dimensions don't change at the other capacity.

Specifications:

Dimension / Material		
Material		Stainless Steel
Protection class		IP 66
Hardness (load area)	HRC	38
Mechanical Data		
Safe Load Limit	% of F.S.	150
Breaking Load	% of F.S.	300
Precision		
Nonlinearity	% of F.S.	±0,5
Nonrepeatability	% of F.S.	±0,25
Hysteresis	% of F.S.	±0,2
Temp. Shift Zero	% of F.S./K.	±0,05
Temp. Shift Span	% of F.S./K.	±0,05
Temperature		
Compensated Temp.	°C	-10...+60
Operating Temp.	°C	-20...+70

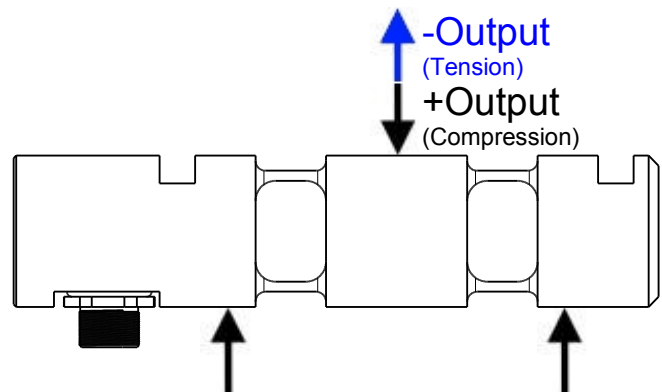

Batarow
 Made in Germany

Batarow Sensorik GmbH
 Pappelweg 16
 18276 Lüssow OT Karow

Mail: info@batarow.com
 Phone: +49 (0) 3843-855555
 Fax : +49 (0) 3843-218842

Internet:
 www.batarow.com

Mounting Situation

MB862 Review: A

Bore fit of mounting situation: H7

Configuration

possible mounting situation / customer mounting could vary

(Please describe mounting situation with Vs, Ws, Xs, Ys and Zs for best possible calibration)

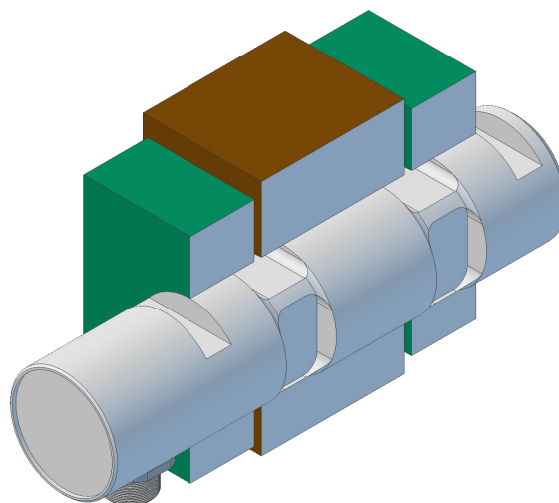
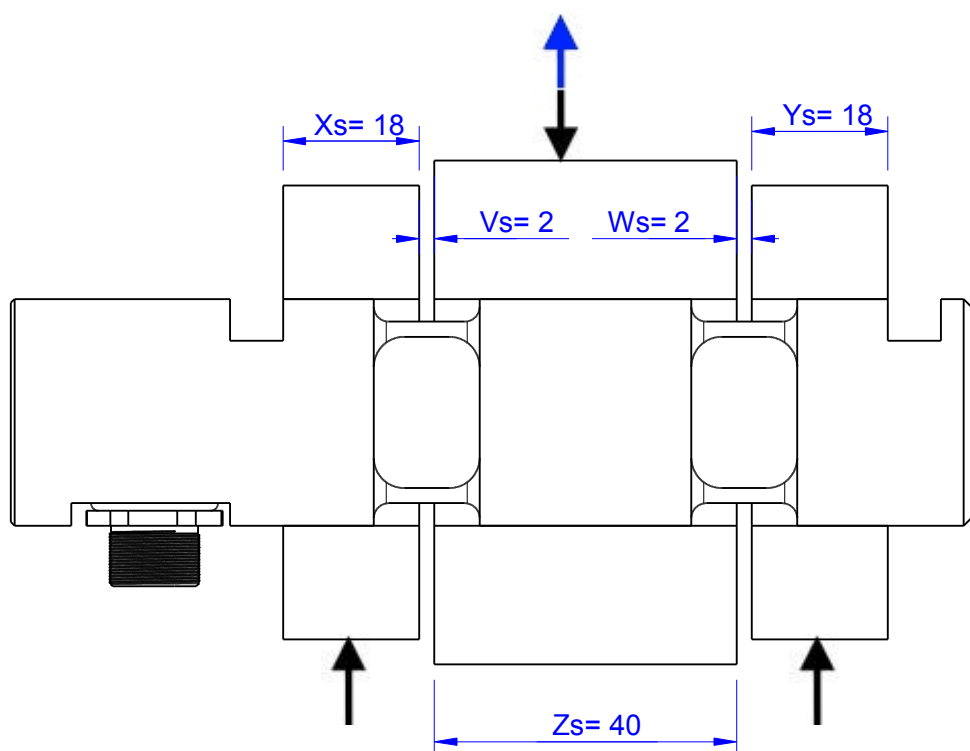

Batarow
Made in Germany

Batarow Sensorik GmbH
Pappelweg 16
18276 Lüssow OT Karow

Mail: info@batarow.com
Phone: +49 (0) 3843-855555
Fax : +49 (0) 3843-218842

Internet:
www.batarow.com

Output Signal & Wiring

MB862 Review: A

Analog Output mV/V (S1)

Electrical Data		
Rated Output	mV/V@F.S.	1
Zero Balance	mV/V	$\pm 0,05$
Exitation (Maximum)	Volt	10
Input Resistance	Ohm	450 ± 100
Output Resistance	Ohm	352 ± 2
Insulating Resistance	GOhm	>5

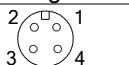
Wiringcode: WC58		Connectortype: M12 (male)			
	Exitation (+) Pin 1	Exitation (-) Pin 2	Bridge (+) Pin 3	Bridge (-) Pin 4	

Ordernumber Add-On:
MBxxx-x-S1-x

Analog Output 1V..10V (U1)*

Electrical Data U1		
Output @ 0kN	V	$1 \pm 0,2$
Output @ F.S.	V	$10 \pm 0,2$
Supply Voltage	V	24 ± 2
Current Consumption	mA	25 (@ 24V)
Bandwidth	kHz	$2,2 \pm 0,2$

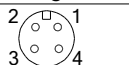
Wiringcode: WC36		Connectortype: M12 (male)	
	Supply (+) Pin 1	GND Pin 3	Output Pin 4

Ordernumber Add-On:
MBxxx-x-U1-x

Analog Output 4..20mA (I1)*

Electrical Data I1		
Output @ 0kN	mA	$4 \pm 0,5$
Output @ F.S.	mA	$20 \pm 0,5$
Supply Voltage	V	24 ± 2
Current Consumption	mA	45 (@ 24V)
Bandwidth	kHz	$2,2 \pm 0,2$

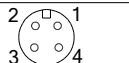
Wiringcode: WC36		Connectortype: M12 (male)	
	Supply (+) Pin 1	GND Pin 3	Output Pin 4

Ordernumber Add-On:
MBxxx-x-I1-x

Attention: Nipple orientation of connector is not fixed. In case of 90° connector - it is necessary to set by customer.

*Attention: With this output configuration is no negative signal (Tension) possible. Please ask our engineering for 4..12..20mA; 1..5..9V or $\pm 10V$ versions.

Batarow
Made in Germany

Batarow Sensorik GmbH
Pappelweg 16
18276 Lüssow OT Karow

Mail: info@batarow.com
Phone: +49 (0) 3843-855555
Fax : +49 (0) 3843-218842

Internet:
www.batarow.com