

MB1538

Load Pin

Content of Loadpin Datasheet

Page 1 ... General

Page 2 ... Mounting Situation

Page 3 ... Output Signal & Wiring

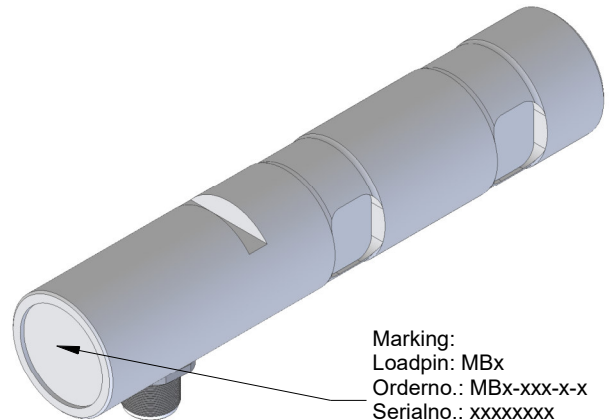
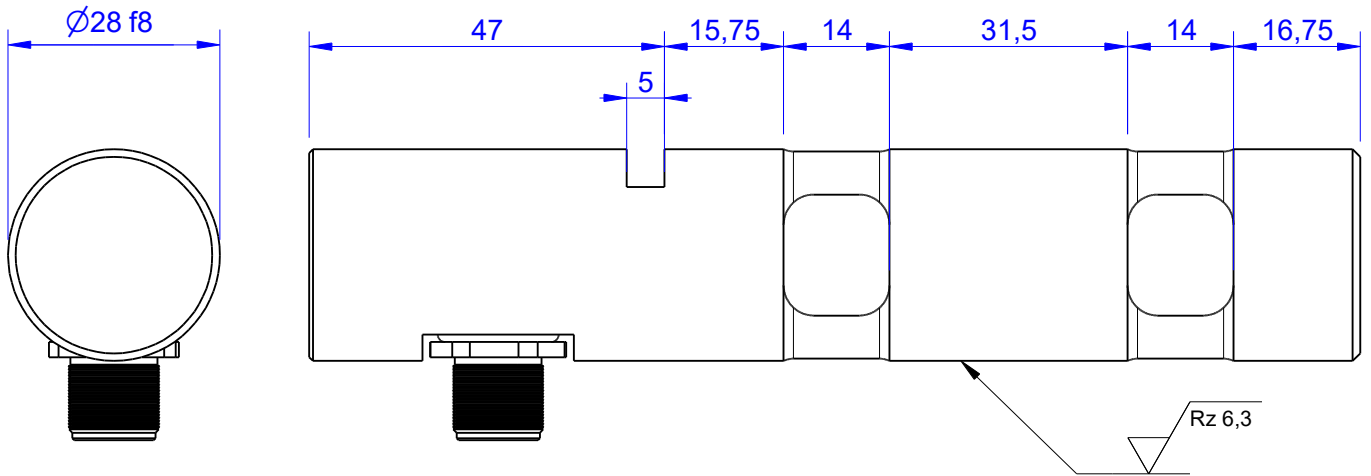

Marking:
Loadpin: MBx
Orderno.: MBx-xxx-x-x
Serialno.: xxxxxxxx
www.batarow.com
Made in Germany

Ordernumber	Capacity [kN] (F.S.)	Uncertainty [kN] (k=2)	Review
MB1538-1-x-A	1	± 0,005	A
MB1538-2-x-A	2	± 0,010	A
MB1538-5-x-A*	5	± 0,025	A
MB1538-10-x-A	10	± 0,050	A
MB1538-15-x-A	15	± 0,075	A

* above showed version
fixed dimensions don't change at other capacity

Specifications:

Dimension / Material		
Material		Stainless Steel
Protection class		IP 66
Hardness (load area)	HRC	40..45
Mechanical Data		
Safe Load Limit	% of F.S.	150
Breaking Load	% of F.S.	300
Precision		
Nonlinearity	% of F.S.	±0,5
Nonrepeatability	% of F.S.	±0,25
Hysteresis	% of F.S.	±0,2
Temp. Shift Zero	% of F.S./K.	±0,05
Temp. Shift Span	% of F.S./K.	±0,05
Temperature		
Compensated Temp.	°C	-10...+60
Operating Temp.	°C	-20...+70

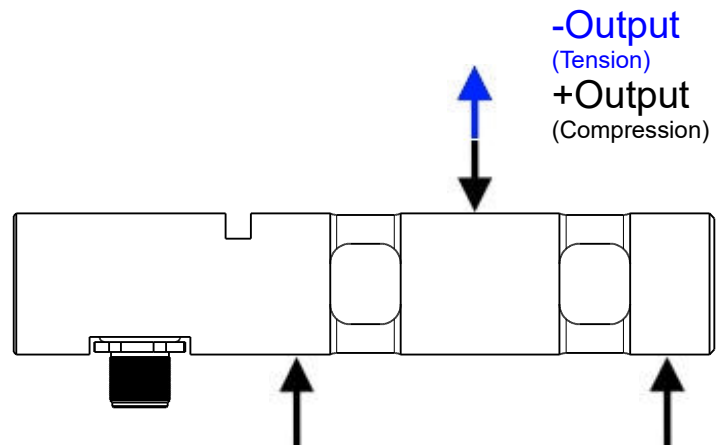

Batarow
Made in Germany

Batarow Sensorik GmbH
Gewerbegebiet 4
18276 Lüssow OT Karow

Mail: info@batarow.com
Phone: +49 (0) 3843-855555
Fax : +49 (0) 3843-855556

Internet:
www.batarow.com

Mounting Situation

MB1538 Review: A

Bore fit of mounting situation: H7

Configuration

possible mounting situation / customer mounting could vary

(Please describe mounting situation with Vs, Ws, Xs, Ys and Zs for best possible calibration)

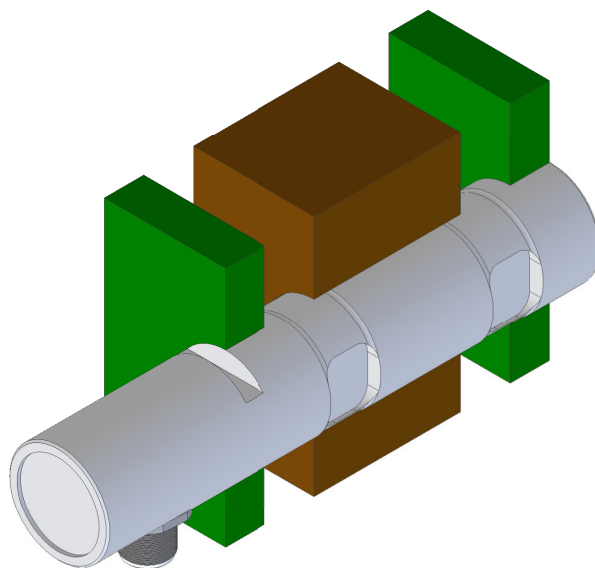
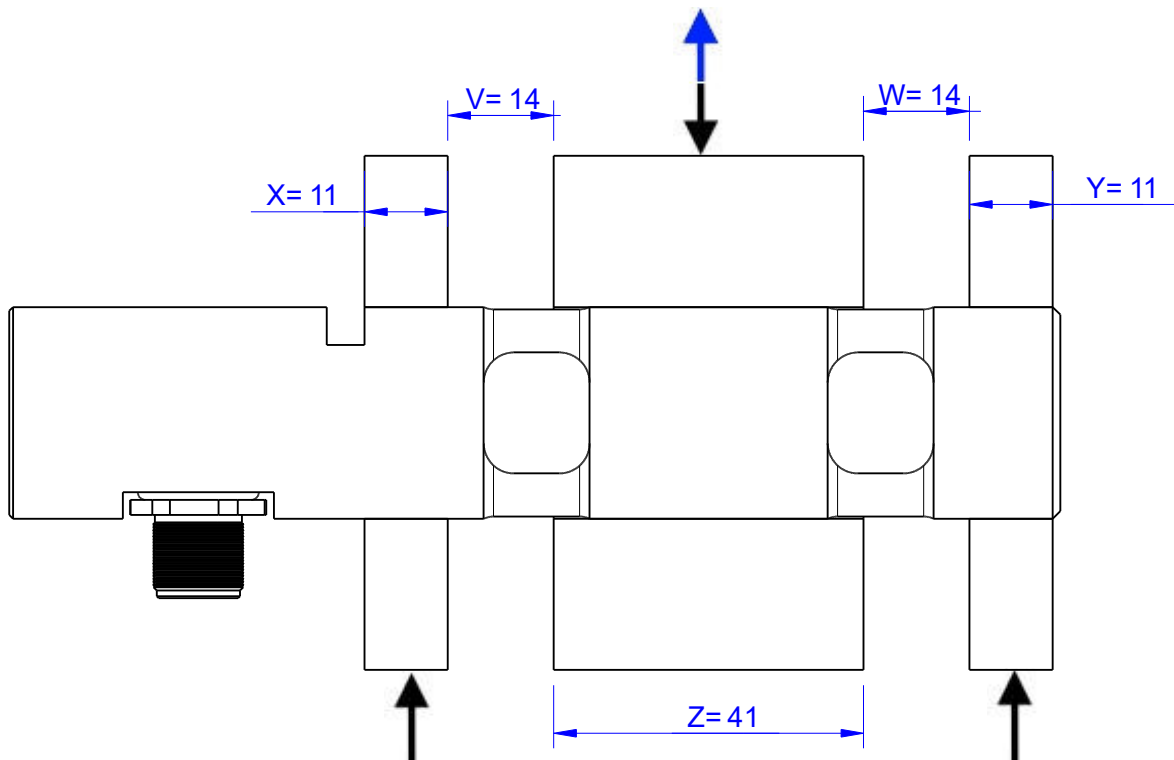

Batarow
Made in Germany

Batarow Sensorik GmbH
Gewerbegebiet 4
18276 Lüssow OT Karow

Mail: info@batarow.com
Phone: +49 (0) 3843-855555
Fax : +49 (0) 3843-855556

Internet:
www.batarow.com

Output Signal & Wiring

MB1538 Review: A

Analog Output mV/V (S1)

Electrical Data		
Rated Output	mV/V@F.S.	1
Zero Balance	mV/V	±0,05
Exitation (Maximum)	Volt	10
Input Resistance	Ohm	450±100
Output Resistance	Ohm	352±2
Insulating Resistance	GOhm	>5

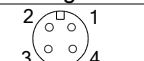
Wiringcode: WC58		Connectortype: M12 (male)			
	Exitation (+) Pin 1	Exitation (-) Pin 2	Bridge (+) Pin 3	Bridge (-) Pin 4	

Ordernumber Add-On:
MBxxx-x-S1-x

Analog Output 1V..10V (U1)*

Electrical Data U1		
Output @ 0kN	V	0
Output @ F.S.	V	10
Supply Voltage	V	14..28
Current Consumption	mA	25 (@ 24V)
Bandwidth	kHz	1

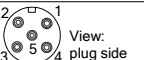
Wiringcode: WC46		Connectortype: M12 (male plug)			
	Supply (+) Pin 1	Output Pin 4	GND Pin 3	Tara Pin 2	Scale Pin 5

Ordernumber Add-On:
MBxxx-x-U1-x

Analog Output 4..20mA (I1)*

Electrical Data I1		
Output @ 0kN	mA	4
Output @ F.S.	mA	20
Supply Voltage	V	14..28
Current Consumption	mA	45 (@ 24V)
Bandwidth	kHz	1

Wiringcode: WC46		Connectortype: M12 (male plug)			
	Supply (+) Pin 1	Output Pin 4	GND Pin 3	Tara Pin 2	Scale Pin 5

Ordernumber Add-On:
MBxxx-x-I1-x

Analog & Switch Output 0V..10V (U20)*

Electrical Data U20		
Output @ 0kN	V	0
Output @ F.S.	V	10
Supply Voltage	V	9..28
Current Consumption	mA	15 (@ 24V)
Bandwidth	Hz	2000
Switching Output		Open Collector
max. Switching current	mA	100

Wiringcode: WC39			
Integrated Amplifier: GSV-6			
Cabeling: M12 Male Socket / Flanschstecker (male)			
Supply(+)	Pin 1	Scale	Pin 5
Ground (-)	Pin 3	Threshold	Pin 6
Output	Pin 4	Output Ground	Pin 7
Tare	Pin 2		

Ordernumber Add-On:
MBxxx-x-U20-x

Analog & Switch Output 4..20mA (I20)*

Electrical Data I20		
Output @ 0kN	mA	4
Output @ F.S.	mA	20
Supply Voltage	V	9..28
Current Consumption	mA	35 (@ 24V)
Bandwidth	Hz	2000
Switching Output		Open Collector
max. Switching current	mA	100

Wiringcode: WC39			
Integrated Amplifier: GSV-6			
Cabeling: M12 Male Socket / Flanschstecker (male)			
Supply(+)	Pin 1	Scale	Pin 5
Ground (-)	Pin 3	Threshold	Pin 6
Output	Pin 4	Output Ground	Pin 7
Tare	Pin 2		

Ordernumber Add-On:
MBxxx-x-I20-x

Attention: Nipple orientation of connector is not fixed. In case of 90° connector - it is necessary to set by customer.

*Attention: With this output configuration is no negative signal (Tension) possible. Please ask our engineering for 4..12..20mA; 1..5..9V or ±10V versions.

Batarow
Made in Germany

Batarow Sensorik GmbH
Gewerbegebiet 4
18276 Lüssow OT Karow

Mail: info@batarow.com
Phone: +49 (0) 3843-855555
Fax : +49 (0) 3843-855556

Internet:
www.batarow.com