

MB1349

Load Pin

Content of Loadpin Datasheet

Page 1 ... General

Page 2 ... Mounting Situation

Page 3 ... Output Signal & Wiring

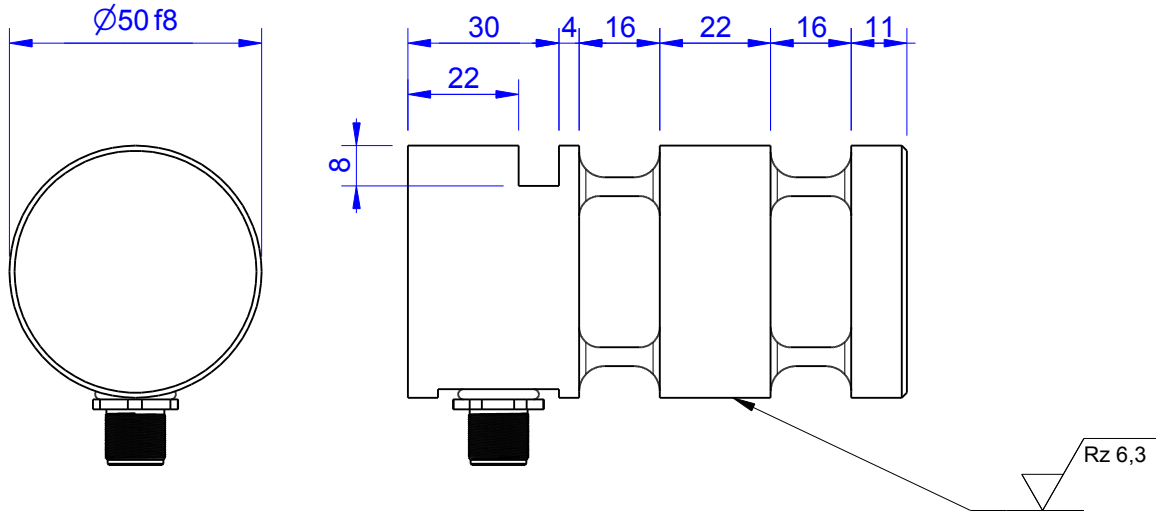

Marking:
 Loadpin: MBx
 Orderno.: MBx-xxx-x-x
 Serialno.: xxxxxxxx
 www.batarow.com
 Made in Germany

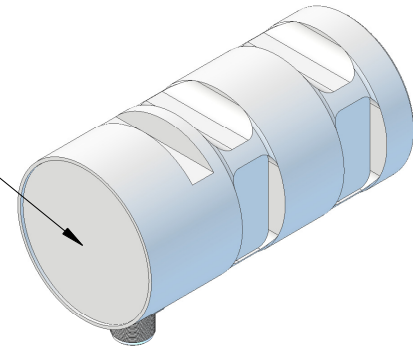

Order-number	Capacity (F.S.)	Uncertainty (k=2)	Review
MB1349-5-x-A	5 kN	±0,03kN	A
MB1349-10-x-A	10 kN	±0,05 kN	A
MB1349-20-x-A	20 kN	±0,10 kN	A
MB1349-40-x-A*	40 kN	±0,20 kN	A
MB1349-100-x-A	100 kN	±0,50 kN	A

* above showed version

The fixed dimensions don't change at the other capacity.

Specifications:

Dimension / Material		
Material		Stainless Steel
Protection class		IP 66
Hardness (load area)	HRC	40..45
Mechanical Data		
Safe Load Limit	% of F.S.	150
Breaking Load	% of F.S.	300
Precision		
Nonlinearity	% of F.S.	±0,5
Nonrepeatability	% of F.S.	±0,25
Hysteresis	% of F.S.	±0,2
Temp. Shift Zero	% of F.S./K.	±0,05
Temp. Shift Span	% of F.S./K.	±0,05
Temperature		
Compensated Temp.	°C	-10...+60
Operating Temp.	°C	-20...+70

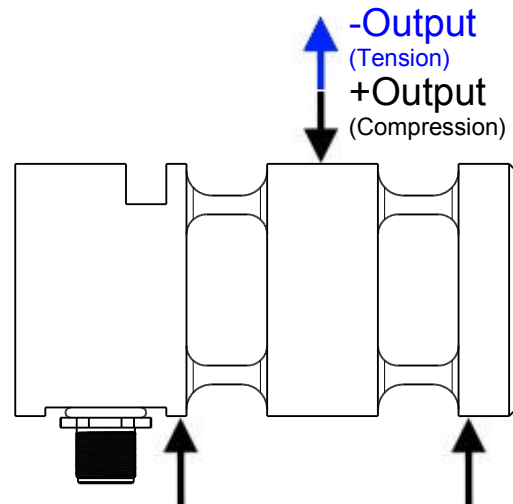

Batarow
 Made in Germany

Batarow Sensorik GmbH
 Gewerbegebiet 4
 18276 Lüssow OT Karow

Mail: info@batarow.com
 Phone: +49 (0) 3843-855555
 Fax : +49 (0) 3843-855556

Internet:
 www.batarow.com

Mounting Situation

MB1349 Review: A

Bore fit of mounting situation: H7

Configuration

possible mounting situation / customer mounting could vary

(Please describe mounting situation with Vs, Ws, Xs, Ys and Zs for best possible calibration)

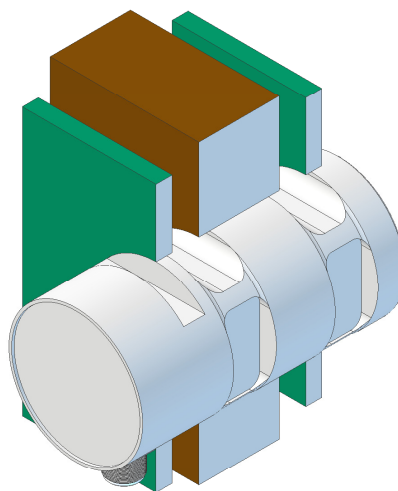
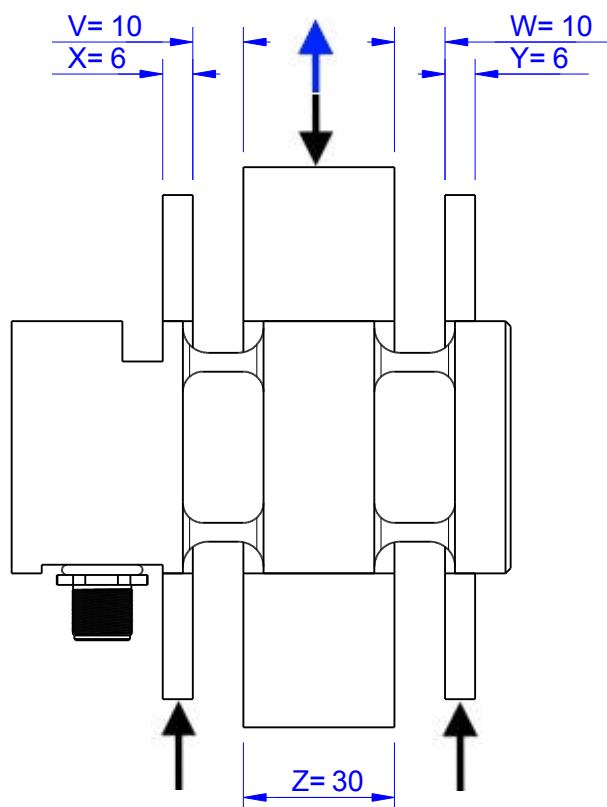

Batarow
Made in Germany

Batarow Sensorik GmbH
Gewerbegebiet 4
18276 Lüssow OT Karow

Mail: info@batarow.com
Phone: +49 (0) 3843-855555
Fax : +49 (0) 3843-855556

Internet:
www.batarow.com

Output Signal & Wiring

MB1349 Review: A

Analog Output mV/V (S1)

Electrical Data		
Rated Output	mV/V@F.S.	1
Zero Balance	mV/V	±0,05
Exitation (Maximum)	Volt	10
Input Resistance	Ohm	450±100
Output Resistance	Ohm	352±2
Insulating Resistance	GOhm	>5

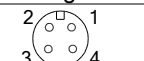
Wiringcode: WC58		Connectortype: M12 (male)			
	Exitation (+) Pin 1	Exitation (-) Pin 2	Bridge (+) Pin 3	Bridge (-) Pin 4	

Ordernumber Add-On:
MBxxx-x-S1-x

Analog Output 1V..10V (U1)*

Electrical Data U1		
Output @ 0kN	V	1
Output @ F.S.	V	10
Supply Voltage	V	14..28
Current Consumption	mA	25 (@ 24V)
Bandwidth	kHz	1

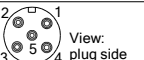
Wiringcode: WC46		Connectortype: M12 (male plug)			
	Supply (+) Pin 1	Output Pin 4	GND Pin 3	Tara Pin 2	Scale Pin 5

Ordernumber Add-On:
MBxxx-x-U1-x

Analog Output 4..20mA (I1)*

Electrical Data I1		
Output @ 0kN	mA	4
Output @ F.S.	mA	20
Supply Voltage	V	14..28
Current Consumption	mA	45 (@ 24V)
Bandwidth	kHz	1

Wiringcode: WC46		Connectortype: M12 (male plug)			
	Supply (+) Pin 1	Output Pin 4	GND Pin 3	Tara Pin 2	Scale Pin 5

Ordernumber Add-On:
MBxxx-x-I1-x

Analog & Switch Output 0V..10V (U20)*

Electrical Data U20		
Output @ 0kN	V	0
Output @ F.S.	V	10
Supply Voltage	V	9..28
Current Consumption	mA	15 (@ 24V)
Bandwidth	Hz	2000
Switching Output		Open Collector
max. Switching current	mA	100

Wiringcode: WC39			
Integrated Amplifier: GSV-6			
Cabeling: M12 Male Socket / Flanschstecker (male)			
Supply(+)	Pin 1	Scale	Pin 5
Ground (-)	Pin 3	Threshold	Pin 6
Output	Pin 4	Output Ground	Pin 7
Tare	Pin 2		

Ordernumber Add-On:
MBxxx-x-U20-x

Analog & Switch Output 4..20mA (I20)*

Electrical Data I20		
Output @ 0kN	mA	4
Output @ F.S.	mA	20
Supply Voltage	V	9..28
Current Consumption	mA	35 (@ 24V)
Bandwidth	Hz	2000
Switching Output		Open Collector
max. Switching current	mA	100

Wiringcode: WC39			
Integrated Amplifier: GSV-6			
Cabeling: M12 Male Socket / Flanschstecker (male)			
Supply(+)	Pin 1	Scale	Pin 5
Ground (-)	Pin 3	Threshold	Pin 6
Output	Pin 4	Output Ground	Pin 7
Tare	Pin 2		

Ordernumber Add-On:
MBxxx-x-I20-x

Attention: Nipple orientation of connector is not fixed. In case of 90° connector - it is necessary to set by customer.

*Attention: With this output configuration is no negative signal (Tension) possible. Please ask our engineering for 4..12..20mA; 1..5..9V or ±10V versions.

Batarow
Made in Germany

Batarow Sensorik GmbH
Gewerbegebiet 4
18276 Lüssow OT Karow

Mail: info@batarow.com
Phone: +49 (0) 3843-855555
Fax : +49 (0) 3843-855556

Internet:
www.batarow.com