

MB1177

Load Pin

Content of Loadpin Datasheet

Page 1 ... General

Page 2 ... Mounting Situation

Page 3 ... Output Signal & Wiring

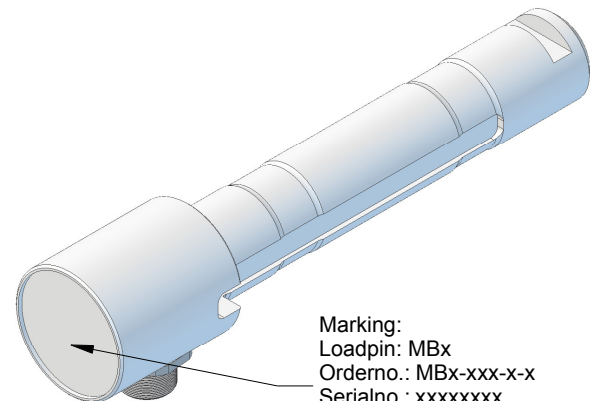
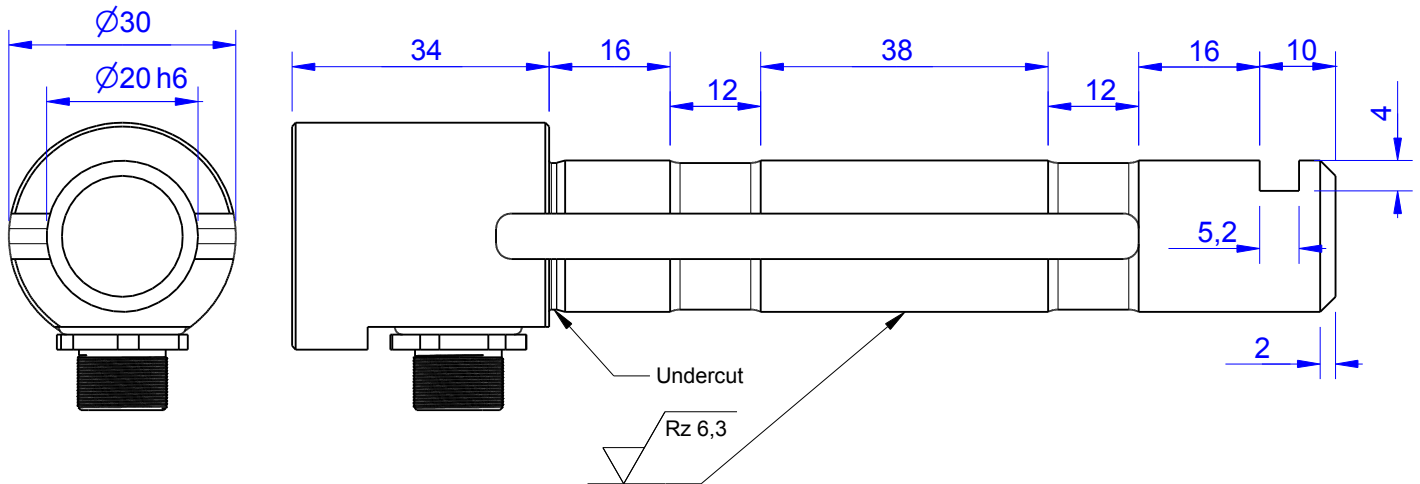

Marking:
 Loadpin: MBx
 Orderno.: MBx-xxx-x-x
 Serialno.: xxxxxxxx
 www.batarow.com
 Made in Germany

Order-number	Capacity (F.S.)	Uncertainty (k=2)	Review
MB1177-2-x-B	2 kN	±0,010kN	B
MB1177-5-x-B	5 kN	±0,025 kN	B
MB1177-10-x-B	10 kN	±0,050 kN	B
MB1177-20-x-B	20 kN	±0,100 kN	B
MB1177-25-x-B*	25 kN	±0,130 kN	B

* above showed version
 The fixed dimensions don't change at the other capacity.

Specifications:

Dimension / Material		
Material		Stainless Steel
Protection class		IP 66
Hardness (load area)	HRC	40..45
Mechanical Data		
Safe Load Limit	% of F.S.	120
Breaking Load	% of F.S.	200
Precision		
Nonlinearity	% of F.S.	±0,5
Nonrepeatability	% of F.S.	±0,25
Hysteresis	% of F.S.	±0,2
Temp. Shift Zero	% of F.S./K.	±0,05
Temp. Shift Span	% of F.S./K.	±0,05
Temperature		
Compensated Temp.	°C	-10...+60
Operating Temp.	°C	-20...+70

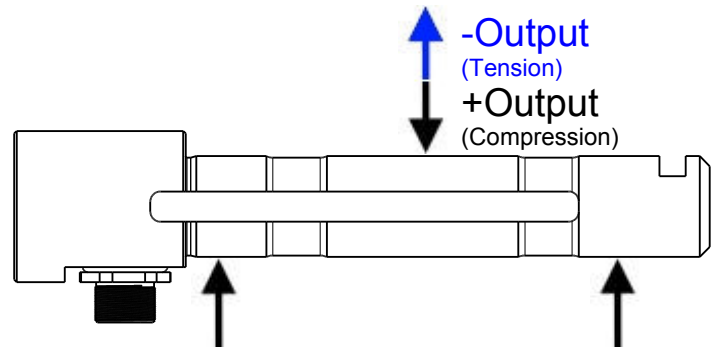

Batarow
 Made in Germany

Batarow Sensorik GmbH
 Pappelweg 16
 18276 Lüssow OT Karow

Mail: info@batarow.com
 Phone: +49 (0) 3843-855555
 Fax : +49 (0) 3843-218842

Internet:
 www.batarow.com

Mounting Situation

MB1177 Review: B

Bore fit of mounting situation: H7

Configuration

possible mounting situation / customer mounting could vary

(Please describe mounting situation with Vs, Ws, Xs, Ys and Zs for best possible calibration)

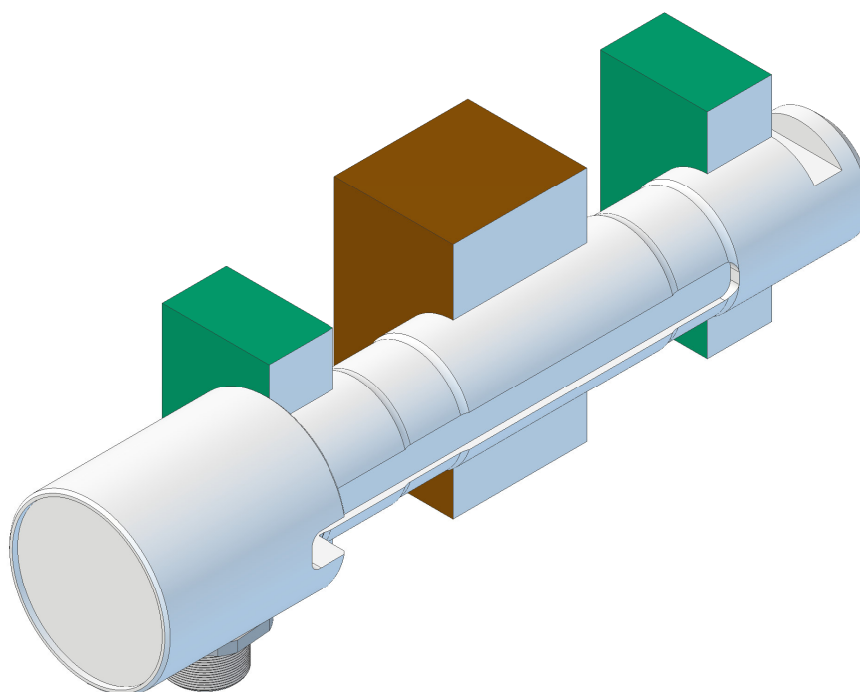
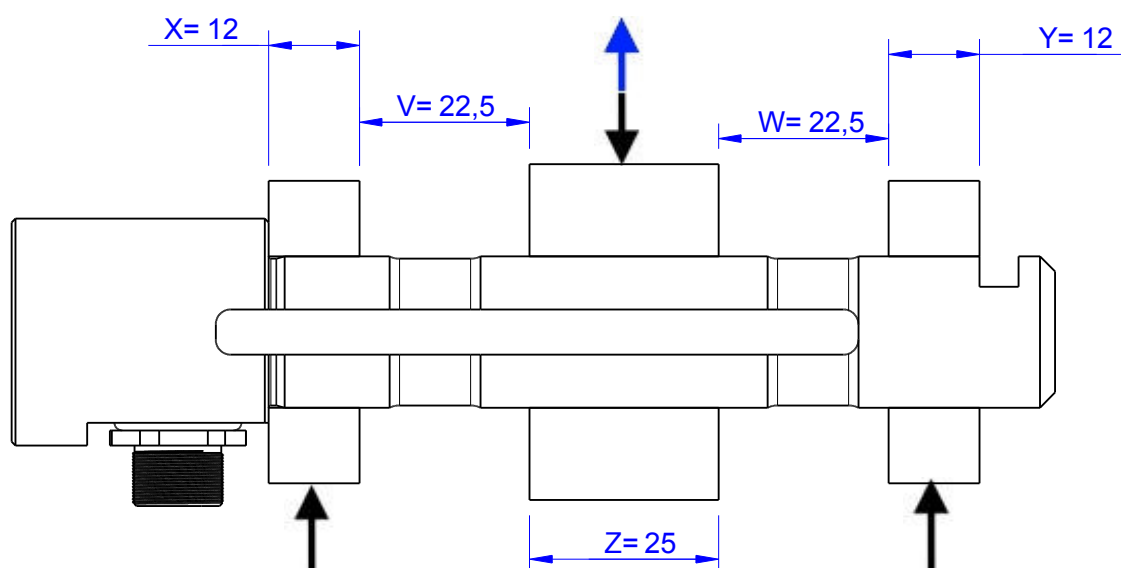

Batarow
Made in Germany

Batarow Sensorik GmbH
Pappelweg 16
18276 Lüssow OT Karow

Mail: info@batarow.com
Phone: +49 (0) 3843-855555
Fax : +49 (0) 3843-218842

Internet:
www.batarow.com

Output Signal & Wiring

MB1177 Review: B

Analog Output mV/V (S1)

Electrical Data		
Rated Output	mV/V@F.S.	1
Zero Balance	mV/V	±0,05
Excitation (Maximum)	Volt	10
Input Resistance	Ohm	450±100
Output Resistance	Ohm	352±2
Insulating Resistance	GOhm	>5

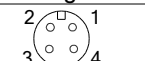
Wiringcode: WC58		Connectortype: M12 (male)			
	Excitation (+) Pin 1	Excitation (-) Pin 2	Bridge (+) Pin 3	Bridge (-) Pin 4	

Ordernumber Add-On:
MBxxx-x-S1-x

Analog Output 1V..10V (U1)*

Electrical Data U1		
Output @ 0kN	V	1±0,2
Output @ F.S.	V	10±0,2
Supply Voltage	V	24±2
Current Consumption	mA	25 (@ 24V)
Bandwidth	kHz	0,3

Wiringcode: WC36		Connectortype: M12 (male)		
	Supply (+) Pin 1	GND Pin 3	Output Pin 4	

Ordernumber Add-On:
MBxxx-x-U1-x

Analog Output 4..20mA (I4)*

Electrical Data I4		
Output @ -F.S.	mA	4±0,3
Output @ 0kN	mA	12±0,3
Output @ +F.S.	mA	20±0,3
Supply Voltage	V	12±1
Current Consumption	mA	45 (@ 12V)
Bandwidth	kHz	2,2±0,2

Wiringcode: WC36		Connectortype: M12 (male)		
	Supply (+) Pin 1	GND Pin 3	Output Pin 4	

Ordernumber Add-On:
MBxxx-x-I4-x

Analog & Switch Output 0V..10V (U20)*

Electrical Data U20		
Output @ 0kN	V	0
Output @ F.S.	V	10
Supply Voltage	V	11..30
Current Consumption	mA	15 (@ 24V)
Bandwidth	Hz	5000
Switching Output		Open Collector
max. Switching current	mA	100

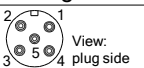
Wiringcode: WC46		Connectortype: M12 (male plug)				
	Supply (+) Pin 1	Output Pin 4	GND Pin 3	Tara Pin 2	Scale Pin 5	

Ordernumber Add-On:
MBxxx-x-U20-x

Analog & Switch Output 4..20mA (I42)*

Electrical Data I42		
Output @ -F.S.	mA	4±0,3
Output @ 0kN	mA	12±0,3
Output @ +F.S.	mA	20±0,3
Supply Voltage	V	11..30
Current Consumption	mA	45 (@ 24V)
Bandwidth	kHz	5±0,2

Wiringcode: WC46		Connectortype: M12 (male plug)				
	Supply (+) Pin 1	Output Pin 4	GND Pin 3	Tara Pin 2	Scale Pin 5	

Ordernumber Add-On:
MBxxx-x-I42-x

Attention: Nipple orientation of connector is not fixed. In case of 90° connector - it is necessary to set by customer.

*Attention: With this output configuration is no negative signal (Tension) possible. Please ask our engineering for 4..12..20mA; 1..5..9V or ±10V versions.

Batarow
Made in Germany

Batarow Sensorik GmbH
Pappelweg 16
18276 Lüssow OT Karow

Mail: info@batarow.com
Phone: +49 (0) 3843-855555
Fax : +49 (0) 3843-218842

Internet:
www.batarow.com